





HIT-HY 200 injection mortar

Anchor design (ETAG 001) / Rods&Sleeves / Concrete

Concrete

Chemical anchors

Mechanical anchors

Injection mortar system	Benefits
 <p>Hilti HIT- HY 200-A 500 ml foil pack (also available as 330 ml foil pack)</p>	<ul style="list-style-type: none"> - SafeSet technology: drilling and borehole cleaning in one step with Hilti hollow drill bit - Suitable for non-cracked and cracked concrete C 20/25 to C 50/60 - ETA Approved for seismic performance category C1, C2^{a)} - Maximum load performance in cracked concrete and non-cracked concrete - High corrosion / corrosion resistance^{b)} - Small edge distance and anchor spacing possible - Manual cleaning for borehole diameter up to 20mm and $h_{ef} \leq 10d$ for non-cracked concrete only - Two mortar versions: HY 200-A for slow cure applications and HY 200-R for fast cure applications
 <p>Hilti HIT- HY 200-R 500 ml foil pack (also available as 330 ml foil pack)</p>	
 <p>Anchor rod: HIT-V HIT-V-F HIT-V-R HIT-V-HCR (M8-M30)</p>	
 <p>Internally threaded sleeve: HIS-N HIS-RN (M8-M20)</p>	
 <p>Anchor rod: HIT-Z HIT-Z-F HIT-Z-R (M8-M20)</p>	

a) HIS-N internally threaded sleeves not approved for Seismic.
b) High Corrosion resistant rods available only for HIT-V. Corrosion resistant rods available for HIT-V and HIS-N

Base material		Installation conditions					
Concrete (non-cracked)	Concrete (cracked)	Hammer drilled holes	Diamond drilled holes ^{c)}	Hilti SafeSet technology	Variable embedment depth	Small edge distance and spacing	
Load conditions		Other information					
Static/quasi-static	Seismic, ETA-C1, C2 ^{a)}	Fire resistance	European Technical Assessment	CE conformity	Corrosion resistance ^{b)}	High corrosion resistance ^{b)}	PROFIS Anchor design Software

a) HIS-N internally threaded sleeves not approved for Seismic category C2.
b) High Corrosion resistant rods available only for HIT-V. Corrosion resistant rods available for HIT-V and HIS-N
c) Diamond drilling only covered for HIT-Z rods



Approvals / certificates

Description	Authority / Laboratory	No. / date of issue
European technical Assessment ^{a)}	DIBt, Berlin	ETA-11/0493/ 2017-07-28 (HY200 A)
European technical Assessment ^{a)}	DIBt, Berlin	ETA-12/0006/ 2017-05-30 (HY200 A)
European technical Assessment ^{a)}	DIBt, Berlin	ETA-12/0084/ 2017-07-28 (HY200 R)
European technical Assessment ^{a)}	DIBt, Berlin	ETA-12/0028/ 2017-05-30 (HY200 R)
Fire test report	IBMB, Brunswick	3501/676/13 / 2012-08-03

a) All data given in this section according to ETA-11/0493, issue 2017-07-28, ETA-12/0006, issue 2017-05-30, ETA-12/0084, issue 2017-07-28 and ETA-12/0028, issue 2017-05-30

Static and quasi-static resistance (for a single anchor)

All data in this section applies to:

- Correct setting (See setting instruction)
- No edge distance and spacing influence
- Steel failure
- Minimum base material thickness
- One typical embedment depth, as specified in the table
- One anchor material, as specified in the tables
- Concrete C 20/25, $f_{ck,cube} = 25 \text{ N/mm}^2$
- Temperature range I (min. base material temp. -40°C , max. long/short term base material temp.: $+24^\circ\text{C}/40^\circ\text{C}$)

For hammer drilled holes, hammer drilled holes with Hilti hollow drill bit:

Anchorage depth ¹⁾

Anchor size		M8	M10	M12	M16	M20	M24	M27	M30
HIT-V									
Embedment depth	[mm]	80	90	110	125	170	210	240	270
Base material thickness	[mm]	110	120	140	161	134	266	300	340
HIS-N									
Embedment depth	[mm]	90	110	125	170	205	-	-	-
Base material thickness	[mm]	120	150	170	230	270	-	-	-
HIT-Z									
Effective anchorage depth ²⁾ $h_{ef}=l_{Helix}$	[mm]	50	60	60	96	100	-	-	-
Effective embedment depth ³⁾ $h_{ef}=h_{nom,min}$	[mm]	70	90	110	145	180	-	-	-
Base material thickness	[mm]	130	150	170	245	280	-	-	-

1) The allowed range of embedment depth is shown in the setting details.

2) For combined pull-out and concrete cone failure

3) For concrete cone failure

Mean ultimate resistance

Anchor size		M8	M10	M12	M16	M20	M24	M27	M30
Non-cracked concrete									
Tension $N_{R,um}$	HIT-V 5.8	18,9	30,5	44,1	83,0	129,2	185,9	241,5	295,1
	HIS-N 8.8	26,3	48,3	70,4	131,3	121,8	-	-	-
	HIT-Z ^{a)}	25,2	39,9	57,8	100,8	153,3	-	-	-
Shear $V_{R,um}$	HIT-V 5.8	9,5	15,8	22,1	41,0	64,1	92,4	120,8	147,0
	HIS-N 8.8	13,7	24,2	35,7	66,2	60,9	-	-	-
	HIT-Z ^{a)}	12,6	20,0	28,4	50,4	76,7	-	-	-
Cracked concrete									
Tension $N_{R,um}$	HIT-V 5.8	18,9	28,2	44,1	66,8	105,9	145,4	177,7	212,0
	HIS-N 8.8	26,3	48,3	66,8	105,9	121,8	-	-	-
	HIT-Z ^{a)}	25,2	39,9	55,1	83,4	115,4	-	-	-
Shear $V_{R,um}$	HIT-V 5.8	9,5	15,8	22,1	41,0	64,1	92,4	120,8	147,0
	HIS-N 8.8	13,7	24,2	35,7	66,2	60,9	-	-	-
	HIT-Z ^{a)}	12,6	20,0	28,4	50,4	76,7	-	-	-

a) Hilti anchor rod HIT-Z-F: M16 and M20

Characteristic resistance

Anchor size		M8	M10	M12	M16	M20	M24	M27	M30
Non-cracked concrete									
Tension N_{Rk}	HIT-V 5.8	18,0	29,0	42,0	70,6	111,9	153,7	187,8	224,0
	HIS-N 8.8	25,0	46,0	67,0	111,9	116,0	-	-	-
	HIT-Z ^{a)}	24,0	38,0	54,3	88,2	122,0	-	-	-
Shear V_{Rk}	HIT-V 5.8	9,0	15,0	21,0	39,0	61,0	88,0	115,0	140,0
	HIS-N 8.8	13,0	23,0	34,0	63,0	58,0	-	-	-
	HIT-Z ^{a)}	12,0	19,0	27,0	48,0	73,0	-	-	-
Cracked concrete									
Tension N_{Rk}	HIT-V 5.8	15,1	21,2	35,2	50,3	79,8	109,6	133,9	159,7
	HIS-N 8.8	24,7	39,9	50,3	79,8	105,7	-	-	-
	HIT-Z ^{a)}	21,1	30,7	41,5	62,9	86,9	-	-	-
Shear V_{Rk}	HIT-V 5.8	9,0	15,0	21,0	39,0	61,0	88,0	115,0	140,0
	HIS-N 8.8	13,0	23,0	34,0	63,0	58,0	-	-	-
	HIT-Z ^{a)}	12,0	19,0	27,0	48,0	73,0	-	-	-

a) Hilti anchor rod HIT-Z-F: M16 and M20

Design resistance

Anchor size		M8	M10	M12	M16	M20	M24	M27	M30
Non-cracked concrete									
Tension N_{Rd}	HIT-V 5.8	12,0	19,3	28,0	47,1	74,6	102,5	125,2	149,4
	HIS-N 8.8	16,7	30,7	44,7	74,6	77,3	-	-	-
	HIT-Z ^{a)}	16,0	25,3	36,2	58,8	81,3	-	-	-
Shear V_{Rd}	HIT-V 5.8	7,2	12,0	16,8	31,2	48,8	70,4	92,0	112,0
	HIS-N 8.8	10,4	18,4	27,2	50,4	46,4	-	-	-
	HIT-Z ^{a)}	9,6	15,2	21,6	38,4	58,4	-	-	-
Cracked concrete									
Tension N_{Rd}	HIT-V 5.8	10,1	14,1	23,5	33,5	53,2	73,0	89,2	106,5
	HIS-N 8.8	16,5	26,6	33,5	53,2	70,4	-	-	-
	HIT-Z ^{a)}	14,1	20,5	27,7	41,9	58,0	-	-	-
Shear V_{Rd}	HIT-V 5.8	7,2	12,0	16,8	31,2	48,8	70,4	92,0	112,0
	HIS-N 8.8	10,4	18,4	27,2	50,4	46,4	-	-	-
	HIT-Z ^{a)}	9,6	15,2	21,6	38,4	58,4	-	-	-

a) Hilti anchor rod HIT-Z-F: M16 and M20

Recommended loads ^{b)}

Anchor size		M8	M10	M12	M16	M20	M24	M27	M30
Non-cracked concrete									
Tension N_{Rec}	HIT-V 5.8	8,6	13,8	20,0	33,6	53,3	73,2	89,4	106,7
	HIS-N 8.8	11,9	21,9	31,9	53,3	55,2	-	-	-
	HIT-Z ^{a)}	11,4	18,1	25,9	42,0	58,1	-	-	-
Shear V_{Rec}	HIT-V 5.8	5,1	8,6	12,0	22,3	34,9	50,3	65,7	80,0
	HIS-N 8.8	7,4	13,1	19,4	36,0	33,1	-	-	-
	HIT-Z ^{a)}	6,9	10,9	15,4	27,4	41,7	-	-	-
Cracked concrete									
Tension N_{Rec}	HIT-V 5.8	7,2	10,1	16,8	24,0	38,0	52,2	63,7	76,1
	HIS-N 8.8	11,9	19,8	23,9	38,0	50,3	-	-	-
	HIT-Z ^{a)}	10,0	14,6	19,8	29,9	41,4	-	-	-
Shear V_{Rec}	HIT-V 5.8	5,1	8,6	12,0	22,3	34,9	50,3	65,7	80,0
	HIS-N 8.8	7,4	13,1	19,4	36,0	33,1	-	-	-
	HIT-Z ^{a)}	6,9	10,9	15,4	27,4	41,7	-	-	-

a) Hilti anchor rod HIT-Z-F: M16 and M20

b) With overall partial safety factor for action $\gamma = 1,4$. The partial safety factors for action depend on the type of loading and shall be taken from national regulations.



Seismic resistance (for a single anchor)

All data in this section applies to:

- Correct setting (See setting instruction with hammer drilling)
- No edge distance and spacing influence
- Steel failure
- Minimum base material thickness
- Concrete C 20/25, $f_{ck,cube} = 25 \text{ N/mm}^2$
- Temperature range I (min. base material temp. -40°C , max. long/short term base material temp.: $+24^\circ\text{C}/40^\circ\text{C}$)
- Installation temperature range -10°C to $+40^\circ\text{C}$
- $\alpha_{gap} = 1,0$ (using Hilti seismic filling set)

For hammer drilled holes and hammer drilled holes with Hilti hollow drill bit:

Anchorage depth for seismic C2

Anchor size		M8	M10	M12	M16	M20	M24	M27	M30
HIT-V									
Embedment depth	h_{ef} [mm]	-	-	-	125	170	210	-	-
HIT-Z									
Effective anchorage depth ²⁾	$h_{ef} = l_{Helix}$ [mm]	-	-	60	96	100	-	-	-
Effective embedment depth ³⁾	h_{ef} [mm]	-	-	110	145	180	-	-	-
Base material thickness	[mm]	-	-	170	245	280	-	-	-

2) For combined pull-out and concrete cone failure

3) For concrete cone failure

Characteristic resistance in case of seismic performance category C2

Anchor size		M8	M10	M12	M16	M20	M24	M27	M30
Tension $N_{Rk,seis}$	HIT-V 8.8, AM 8.8	-	-	-	24,5	45,9	55,4	-	-
	HIT-Z ^{a)}	-	-	29,4	53,4	73,9	-	-	-
Shear $V_{Rk,seis}$	HIT-V 8.8, AM 8.8	-	-	-	46,0	77,0	103,0	-	-
	HIT-Z ^{a)}	-	-	23,0	41,0	61,0	-	-	-

a) Hilti anchor rod HIT-Z-F: M16 and M20

Design resistance in case of seismic performance category C2

Anchor size		M8	M10	M12	M16	M20	M24	M27	M30
Tension $N_{Rd,seis}$	HIT-V 8.8, AM 8.8	-	-	-	16,3	30,6	36,9	-	-
	HIT-Z ^{a)}	-	-	19,6	35,6	49,3	-	-	-
Shear $V_{Rd,seis}$	HIT-V 8.8, AM 8.8	-	-	-	36,8	61,6	82,4	-	-
	HIT-Z ^{a)}	-	-	18,4	32,8	48,8	-	-	-

a) Hilti anchor rod HIT-Z-F: M16 and M20

Anchorage depth for seismic C1

Anchor size		M8	M10	M12	M16	M20	M24	M27	M30
HIT-V									
Embedment depth	h_{ef} [mm]	-	90	110	125	170	210	240	270
HIT-Z									
Effective anchorage depth ¹⁾	$h_{ef} = l_{Helix}$ [mm]	50	60	60	96	100	-	-	-
Effective embedment depth ²⁾	h_{ef} [mm]	70	90	110	145	180	-	-	-
Base material thickness	[mm]	-	-	170	245	280	-	-	-

1) For combined pull-out and concrete cone failure

2) For concrete cone failure

Characteristic resistance in case of seismic performance category C1

Anchor size		M8	M10	M12	M16	M20	M24	M27	M30
Tension $N_{Rk,seis}$	HIT-V 8.8, AM 8.8	-	14,7	29,0	42,8	67,8	93,1	113,8	135,8
	HIT-Z ^{a)} ; HIT-Z-R	17,9	26,1	35,3	53,4	73,9	-	-	-
Shear $V_{Rk,seis}$	HIT-V 8.8, AM 8.8	-	23,0	34,0	63,0	98,0	141,0	184,0	224,0
	HIT-Z ^{a)}	7,0	17,0	16,0	28,0	45,0	-	-	-
	HIT-Z-R	8,0	19,0	22,0	31,0	48,0	-	-	-

a) Hilti anchor rod HIT-Z-F: M16 and M20

Design resistance in case of seismic performance category C1

Anchor size		M8	M10	M12	M16	M20	M24	M27	M30
Tension $N_{Rd,seis}$	HIT-V 8.8, AM 8.8	-	9,8	19,4	28,5	45,2	62,1	75,8	90,5
	HIT-Z ^{a)} ; HIT-Z-R	11,9	17,4	23,5	35,6	49,3	-	-	-
Shear $V_{Rd,seis}$	HIT-V 8.8, AM 8.8	-	18,4	27,2	50,4	78,4	112,8	147,2	179,2
	HIT-Z ^{a)}	5,6	13,6	12,8	22,4	36,0	-	-	-
	HIT-Z-R	6,4	15,2	17,6	24,8	38,4	-	-	-

a) Hilti anchor rod HIT-Z-F: M16 and M20

Materials

Materials properties for HIT-V

Anchor size		M8	M10	M12	M16	M20	M24	M27	M30
Nominal tensile strength f_{uk}	HIT-V 5.8 (F)	500	500	500	500	500	500	500	500
	HIT-V 8.8 (F)	800	800	800	800	800	800	800	800
	AM 8.8 (HDG)								
	HIT-V-R	700	700	700	700	700	700	500	500
HIT-V-HCR	800	800	800	800	800	700	700	700	
Yield strength f_{yk}	HIT-V 5.8 (F)	400	400	400	400	400	400	400	400
	HIT-V 8.8 (F)	640	640	640	640	640	640	640	640
	AM 8.8 (HDG)								
	HIT-V-R	450	450	450	450	450	450	210	210
HIT-V-HCR	640	640	640	640	640	400	400	400	
Stressed cross-section A_s	HIT-V	36,6	58,0	84,3	157	245	353	459	561
Moment of resistance W	HIT-V	31,2	62,3	109	277	541	935	1387	1874

Mechanical properties for HIS-N

Anchor size		M8	M10	M12	M16	M20
Nominal tensile strength f_{uk}	HIS-N	490	490	460	460	460
	Screw 8.8	800	800	800	800	800
	HIS-RN	700	700	700	700	700
	Screw A4-70	700	700	700	700	700
Yield strength f_{yk}	HIS-N	410	410	375	375	375
	Screw 8.8	640	640	640	640	640
	HIS-RN	350	350	350	350	350
	Screw A4-70	450	450	450	450	450
Stressed cross-section A_s	HIS-(R)N	51,5	108,0	169,1	256,1	237,6
	Screw	36,6	58	84,3	157	245
Moment of resistance W	HIS-(R)N	145	430	840	1595	1543
	Screw	31,2	62,3	109	277	541

Concrete
Chemical anchors
Mechanical anchors
Plastic / Light duty metal anchors



Mechanical properties for HIT-Z

Anchor size		M8	M10	M12	M16	M20
Nominal tensile strength f_{uk}	HIT-Z(-F) ^{a)} [N/mm ²]	650	650	650	610	595
	HIT-Z-R	650	650	650	610	595
Yield strength f_{yk}	HIT-Z(-F) ^{a)} [N/mm ²]	520	520	520	490	480
	HIT-Z-R	520	520	520	490	480
Stressed cross-section of thread A_s	HIT-Z(-F) ^{a)} [mm ²] HIT-Z-R	36,6	58,0	84,3	157	245
Moment of resistance W	HIT-Z(-F) ^{a)} [mm ³] HIT-Z-R	31,9	62,5	109,7	278	542

a) Hilti anchor rod HIT-Z-F: M16 and M20

Material quality for HIT-V

Part	Material
Zinc coated steel	
Threaded rod, HIT-V 5.8 (F)	Strength class 5.8; Elongation at fracture A5 > 8% ductile Electroplated zinc coated $\geq 5\mu\text{m}$; (F) hot dip galvanized $\geq 45\mu\text{m}$
Threaded rod, HIT-V 8.8 (F)	Strength class 8.8; Elongation at fracture A5 > 12% ductile Electroplated zinc coated $\geq 5\mu\text{m}$; (F) hot dip galvanized $\geq 45\mu\text{m}$
Hilti Meter rod, AM 8.8 (HDG)	Strength class 8.8; Elongation at fracture A5 > 12% ductile Electroplated zinc coated $\geq 5\mu\text{m}$ (HDG) hot dip galvanized $\geq 45\mu\text{m}$
Washer	Electroplated zinc coated $\geq 5\mu\text{m}$, hot dip galvanized $\geq 45\mu\text{m}$
Nut	Strength class of nut adapted to strength class of threaded rod. Electroplated zinc coated $\geq 5\mu\text{m}$, hot dip galvanized $\geq 45\mu\text{m}$
Hilti Filling set (F)	Filling washer: Electroplated zinc coated $\geq 5\mu\text{m}$ / (F) Hot dip galvanized $\geq 45\mu\text{m}$
	Spherical washer: Electroplated zinc coated $\geq 5\mu\text{m}$ / (F) Hot dip galvanized $\geq 45\mu\text{m}$
	Lock nut: Electroplated zinc coated $\geq 5\mu\text{m}$ / (F) Hot dip galvanized $\geq 45\mu\text{m}$
Stainless Steel	
Threaded rod, HIT-V-R	Strength class 70 for $\leq M24$ and strength class 50 for $> M24$; Elongation at fracture A5 > 8% ductile Stainless steel 1.4401; 1.4404; 1.4578; 1.4571; 1.4439; 1.4362
Washer	Stainless steel 1.4401, 1.4404, 1.4578, 1.4571, 1.4439, 1.4362 EN 10088-1:2014
Nut	Stainless steel 1.4401, 1.4404, 1.4578, 1.4571, 1.4439, 1.4362 EN 10088-1:2014
High corrosion resistant steel	
Threaded rod, HIT-V-HCR	Strength class 80 for $\leq M20$ and class 70 for $> M20$, Elongation at fracture A5 > 8% ductile High corrosion resistance steel 1.4529; 1.4565;
Washer	High corrosion resistant steel 1.4529, 1.4565 EN 10088-1:2014
Nut	High corrosion resistant steel 1.4529, 1.4565 EN 10088-1:2014

Material quality for HIS-N

Part	Material	
HIS-N	Int. threaded sleeve	Electroplated zinc coated $\geq 5\mu\text{m}$
	Screw 8.8	Strength class 8.8, A5 > 8 % Ductile; Steel galvanized $\geq 5\mu\text{m}$
HIS-RN	Int. threaded sleeve	Stainless steel 1.4401, 1.4571
	Screw 70	Strength class 70, A5 > 8 % Ductile; Stainless steel 1.4401; 1.4404, 1.4578; 1.4571; 1.4439; 1.4362

Material quality for HIT-Z

Part	Material
Threaded rod HIT-Z	Elongation at fracture > 8% ductile; Electroplated zinc coated $\geq 5 \mu\text{m}$
Washer	Electroplated zinc coated $\geq 5 \mu\text{m}$
Nut	Strength class of nut adapted to strength class of anchor rod. Electroplated zinc coated $\geq 5 \mu\text{m}$
HIT-Z-F	Elongation at fracture > 8% ductile Multilayer coating, ZnNi-galvanized according to DIN 50979:2008-07
Washer	Multilayer coating, ZnNi-galvanized according to DIN 50979:2008-07
Nut	Multilayer coating, ZnNi-galvanized according to DIN 50979:2008-07
HIT-Z-R	Elongation at fracture > 8% ductile; Stainless steel 1.4401, 1.4404 EN 10088-1:2014
Washer	Stainless steel A4 according to EN 10088-1:2014
Nut	Strength class of nut adapted to strength class of anchor rod. Stainless steel 1.4401, 1.4404 EN 10088-1:2014

Setting information

In service temperature range

Hilti HIT-HY 200 A (R) injection mortar with anchor rod HIT-V / HIS-(R)N may be applied in the temperature ranges given below. An elevated base material temperature leads to a reduction of the design bond resistance.

Temperature in the base material

Temperature range	Base material temperature	Maximum long term base material temperature	Maximum short term base material temperature
Temperature range I	-40 °C to +40 °C	+24 °C	+40 °C
Temperature range II	-40 °C to +80 °C	+50 °C	+80 °C
Temperature range III	-40 °C to +120 °C	+72 °C	+120 °C

Max short term base material temperature

Short-term elevated base material temperatures are those that occur over brief intervals, e.g. as a result of diurnal cycling.

Max long term base material temperature

Long-term elevated base material temperatures are roughly constant over significant periods of time.

Curing and working time

Temperature of the base material	HIT-HY 200-A		HIT-HY 200-R	
	Maximum working time t_{work}	Minimum curing time t_{cure}	Maximum working time t_{work}	Minimum curing time t_{cure}
$-10^{\circ}\text{C} < T_{\text{BM}} \leq -5^{\circ}\text{C}$	1,5 h	7 h	3 h	20 h
$-5^{\circ}\text{C} < T_{\text{BM}} \leq 0^{\circ}\text{C}$	50 min	4 h	2 h	8 h
$0^{\circ}\text{C} < T_{\text{BM}} \leq 5^{\circ}\text{C}$	25 min	2 hour	1 h	4 h
$5^{\circ}\text{C} < T_{\text{BM}} \leq 10^{\circ}\text{C}$	15 min	75 min	40 min	2,5 h
$10^{\circ}\text{C} < T_{\text{BM}} \leq 20^{\circ}\text{C}$	7 min	45 min	15 min	1,5 h
$20^{\circ}\text{C} < T_{\text{BM}} \leq 30^{\circ}\text{C}$	4 min	30 min	9 min	1 h
$30^{\circ}\text{C} < T_{\text{BM}} \leq 40^{\circ}\text{C}$	3 min	30 min	6 min	1 h



Setting details for HIT-V

Anchor size	M8	M10	M12	M16	M20	M24	M27	M30	
Nominal diameter of drill bit d [mm]	10	12	14	18	22	28	30	35	
Eff. embedment depth and drill hole depth ^{a)}	$h_{ef,min}$ [mm]	60	60	70	80	90	96	108	120
	$h_{ef,max}$ [mm]	160	200	240	320	400	480	540	600
Minimum base material thickness	h_{min} [mm]	$h_{ef} + 30 \text{ mm} \geq 100 \text{ mm}$			$h_{ef} + 2 d_0$				
Maximum diameter of clearance hole in the fixture	d_f [mm]	9	12	14	18	22	26	30	33
Thickness of Hilti filling set	h_{fs} [mm]	-	-	-	11	13	15	-	-
Effective fixture thickness with Hilti filling set	$t_{fix,eff}$ [mm]	$t_{fix,eff} - h_{fs}$							
Max. torque moment ^{b)}	T_{max} [Nm]	10	20	40	80	150	200	270	300
Minimum spacing	s_{min} [mm]	40	50	60	75	90	115	120	140
Minimum edge distance	c_{min} [mm]	40	45	45	50	55	60	75	80
Critical spacing for splitting failure	$s_{cr,sp}$ [mm]	$2 C_{cr,sp}$							
Critical edge distance for splitting failure ^{c)}	$C_{cr,sp}$ [mm]	$1,0 \cdot h_{ef}$ for $h / h_{ef} \geq 2,00$							
		$4,6 h_{ef} - 1,8 h$ for $2,00 > h / h_{ef} > 1,3$							
		$2,26 h_{ef}$ for $h / h_{ef} \leq 1,3$							
Critical spacing for concrete cone failure	$s_{cr,N}$ [mm]	$2 C_{cr,sp}$							
Critical edge distance for concrete cone failure ^{d)}	$C_{cr,N}$ [mm]	$1,5 h_{ef}$							

For spacing (edge distance) smaller than critical spacing (critical edge distance) the design loads have to be reduced.

- a) $h_{ef,min} \leq h_{ef} \leq h_{ef,max}$ (h_{ef} : embedment depth)
- b) Maximum recommended torque moment to avoid splitting failure during installation with minimum spacing and edge distance
- c) h : base material thickness ($h \geq h_{min}$)
- d) The critical edge distance for concrete cone failure depends on the embedment depth h_{ef} and the design bond resistance. The simplified formula given in this table is on the safe side.

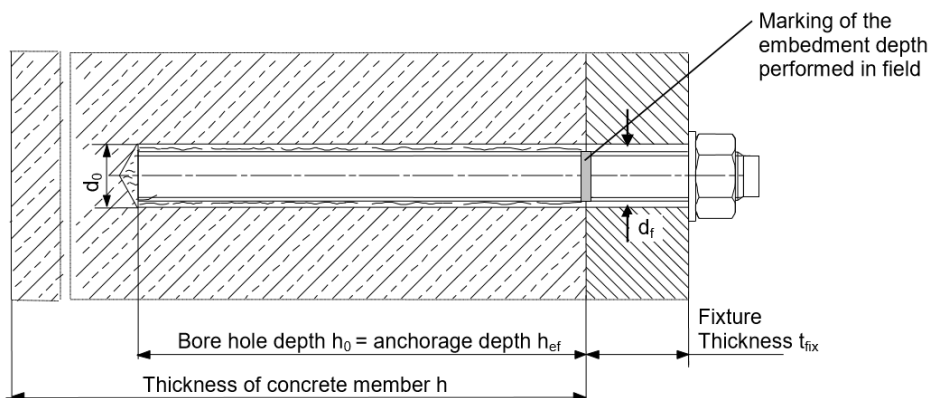
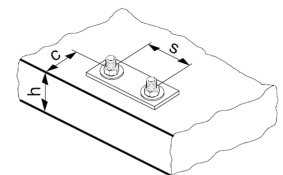

Setting details for HIS-N

Anchor size		M8	M10	M12	M16	M20
Nominal diameter of drill bit d_0	[mm]	14	18	22	28	32
Diameter of element d	[mm]	12,5	16,5	20,5	25,4	27,6
Effective anchorage and drill hole depth h_{ef}	[mm]	90	110	125	170	205
Minimum base material thickness h_{min}	[mm]	120	150	170	230	270
Diameter of clearance hole in the fixture d_f	[mm]	9	12	14	18	22
Thread engagement length; min - max h_s	[mm]	8-20	10-25	12-30	16-40	20-50
Minimum spacing s_{min}	[mm]	60	75	90	115	130
Minimum edge distance c_{min}	[mm]	40	45	55	65	90
Critical spacing for splitting failure $s_{cr,sp}$	[mm]	$2 C_{cr,sp}$				
Critical edge distance for splitting failure ^{b)} $c_{cr,sp}$	[mm]	$1,0 \cdot h_{ef}$ for $h / h_{ef} \geq 2,0$				
		$4,6 h_{ef} - 1,8 h$ for $2,0 > h / h_{ef} > 1,3$				
		$2,26 h_{ef}$ for $h / h_{ef} \leq 1,3$				
Critical spacing for concrete cone failure $s_{cr,N}$	[mm]	$2 C_{cr,N}$				
Critical edge distance for concrete cone failure ^{c)} $c_{cr,N}$	[mm]	$1,5 h_{ef}$				
Max. torque moment ^{a)} T_{max}	[Nm]	10	20	40	80	150

For spacing (edge distance) smaller than critical spacing (critical edge distance) the design loads have to be reduced.

- a) Max. recommended torque moment to avoid splitting failure during Installation with minimum spacing and edge distance
- b) h : base material thickness ($h \geq h_{min}$)
- c) The critical edge distance for concrete cone failure depends on the embedment depth h_{ef} and the design bond resistance. The simplified formula given in this table is on the save side.

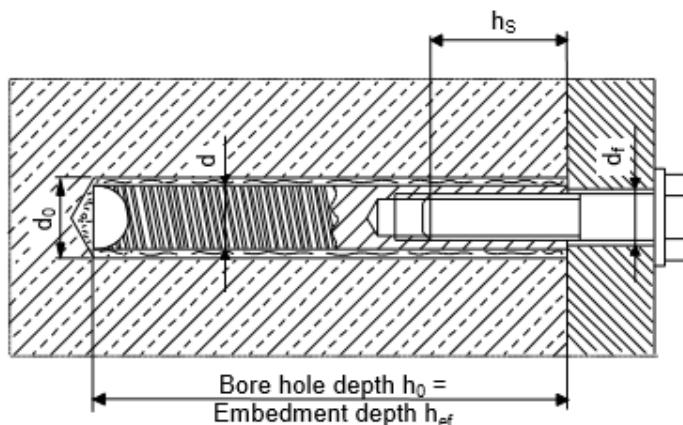
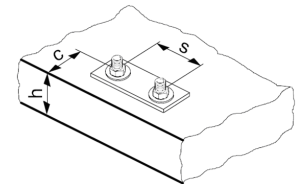



Settings details HIT-Z, HIT-Z-F and HIT-Z-R

Anchor size		M8	M10	M12	M16	M20
Nominal diameter of drill bit	d_0 [mm]	10	12	14	18	22
Length of anchor	min l [mm]	80	95	105	155	215
	max l [mm]	120	160	196	420	450
Nominal embedment depth range ^{a)}	$h_{nom,min}$ [mm]	60	60	60	96	100
	$h_{nom,max}$ [mm]	100	120	144	192	220
Borehole condition 1 Min. base material thickness	h_{min} [mm]	$h_{nom} + 60$ mm			$h_{nom} + 100$ mm	
Borehole condition 2 Min. base material thickness	h_{min} [mm]	$h_{nom} + 30$ mm ≥ 100 mm			$h_{nom} + 45$ mm ≥ 45 mm	
Maximum depth of drill hole	h_0 [mm]	$h - 30$ mm			$h - 2 d_0$	
Pre-setting: Diameter of clearance hole in the fixture	d_f [mm]	9	12	14	18	22
Through-setting: Diameter of clearance hole in the fixture	d_f [mm]	11	14	16	20	24
Maximum fixture thickness	t_{fix} [mm]	48	87	120	303	326
Maximum fixture thickness with seismic filling set	t_{fix} [mm]	41	79	111	292	314
Installation torque moment ^{b)}	T_{inst} [Nm]	10	25	40	80	150
Critical spacing for splitting failure	$s_{cr,sp}$ [mm]	$2 C_{cr,sp}$				
Critical edge distance for splitting failure ^{c)}	$c_{cr,sp}$ [mm]	$1,5 \cdot h_{nom}$ for $h / h_{nom} \geq 2,35$				
		$6,2 h_{nom} - 2,0 h$ for $2,35 > h / h_{nom} > 1,35$				
		$3,5 h_{nom}$ for $h / h_{nom} \leq 1,35$				
Critical spacing for concrete cone failure	$s_{cr,N}$ [mm]	$2 C_{cr,N}$				
Critical edge distance concrete cone failure ^{d)}	$c_{cr,N}$ [mm]	$1,5 h_{nom}$				

For spacing (edge distance) smaller than critical spacing (critical edge distance) the design loads have to be reduced.

- a) $h_{nom,min} \leq h_{nom} \leq h_{nom,max}$ (h_{nom} : embedment depth)
- b) Recommended torque moment to avoid splitting failure during installation with minimum spacing and edge distance
- c) h : base material thickness ($h \geq h_{min}$)
- d) The critical edge distance for concrete cone failure depends on the embedment depth h_{ef} and the design bond resistance. The simplified formula given in this table is on the safe side.

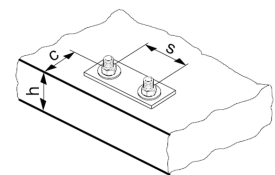

Pre-setting:

Install anchor before positioning fixture

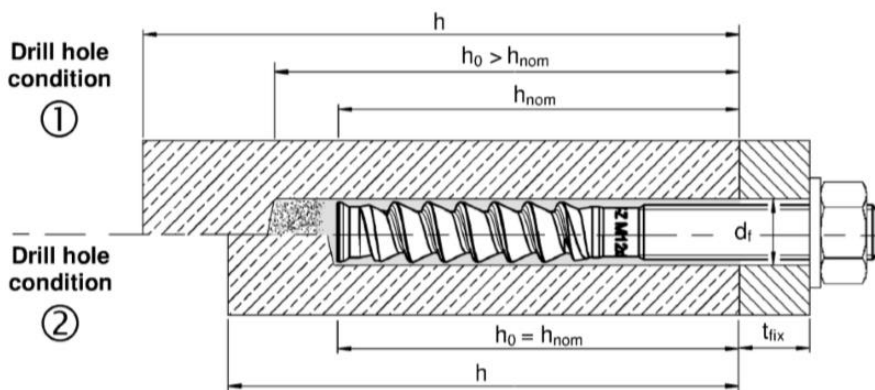

Drill hole condition 1 → non-cleaned borehole
 Drill hole condition 2 → drilling dust is completely removed

Through-setting: Install anchor through positioned fixture

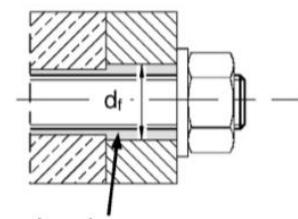

Annular gap filled with Hilti HIT-HY 200-A

Anchor dimension for HIT-Z

Anchor size			M8	M10	M12	M16	M20
Length of anchor	min l	[mm]	80	95	105	155	215
	max l		120	160	196	420	450
Helix length	l_{Helix}	[mm]	50	60	60	96	100

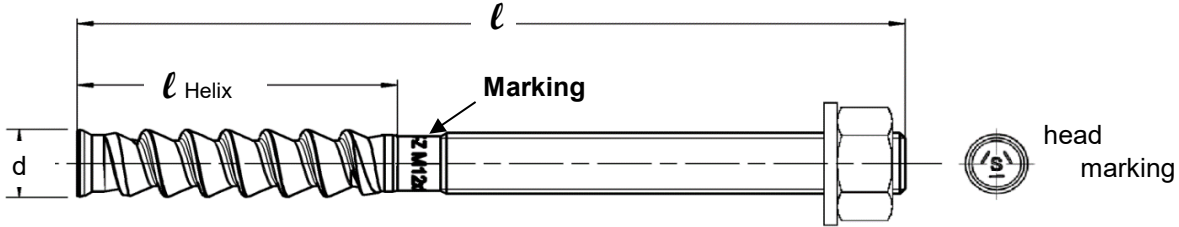
Minimum edge distance and spacing for HIT-Z

For the calculation of minimum spacing and minimum edge distance of anchors in combination with different embedment depth and thickness of concrete member the following equation shall be fulfilled: $A_{i, \text{req}} < A_{i, \text{cal}}$

Required interaction area $A_{i, \text{cal}}$ for HIT-Z

Anchor size			M8	M10	M12	M16	M20
Cracked concrete	[mm ²]		19200	40800	58800	94700	148000
Non-cracked concrete	[mm ²]		22200	57400	80800	128000	198000

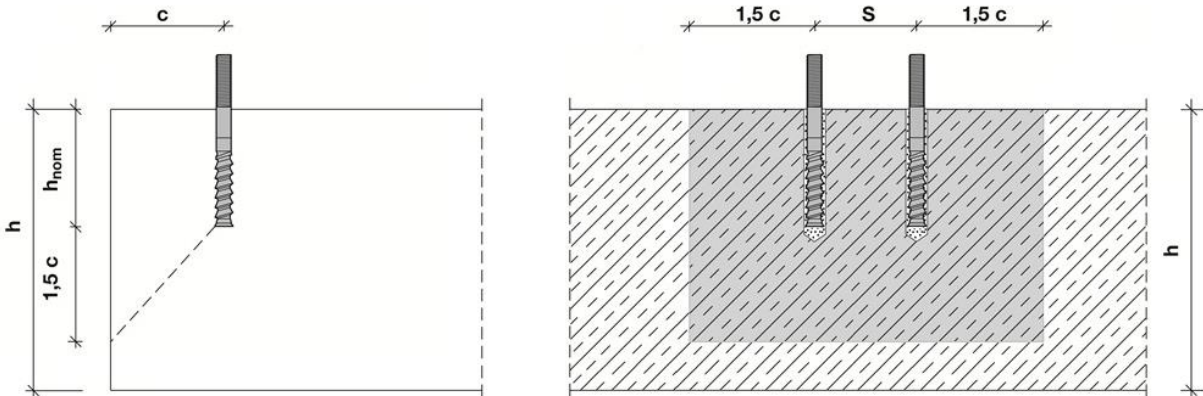
Effective area $A_{i, \text{ef}}$ of HIT-Z
Member thickness $h \geq h_{\text{nom}} + 1,5 \cdot c$

Single anchor and group of anchors with $s > 3 \cdot c$	[mm ²]	$A_{i, \text{cal}} = (6 \cdot c) \cdot (h_{\text{nom}} + 1,5 \cdot c)$	with $c \geq 5 \cdot d$
Group of anchors with $s \leq 3 \cdot c$	[mm ²]	$A_{i, \text{cal}} = (3 \cdot c + s) \cdot (h_{\text{nom}} + 1,5 \cdot c)$	with $c \geq 5 \cdot d$ and $s \geq 5 \cdot d$

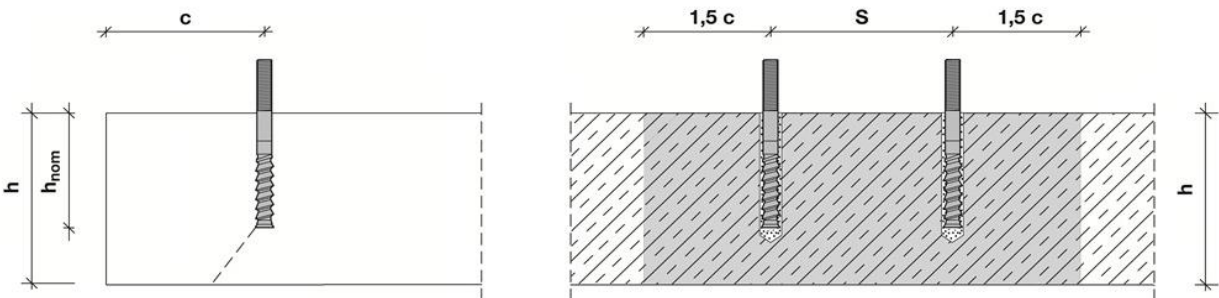
Member thickness $h \leq h_{\text{nom}} + 1,5 \cdot c$

Single anchor and group of anchors with $s >$	[mm ²]	$A_{i, \text{cal}} = (6 \cdot c) \cdot h$	with $c \geq 5 \cdot d$
Group of anchors with $s \leq 3 \cdot c$	[mm ²]	$A_{i, \text{cal}} = (3 \cdot c + s) \cdot h$	with $c \geq 5 \cdot d$ and $s \geq 5 \cdot d$



Best case minimum edge distance and spacing with required member thickness and embedment depth

Anchor size		M8	M10	M12	M16	M20
Cracked concrete						
Member thickness	$h \geq$ [mm]	140	200	240	300	370
Embedment depth	$h_{nom} \geq$ [mm]	80	120	150	200	220
Minimum spacing	s_{min} [mm]	40	50	60	80	100
Corresponding edge distance	$c \geq$ [mm]	40	55	65	80	100
Minimum edge distance	$c_{min} =$ [mm]	40	50	60	80	100
Corresponding spacing	$s \geq$ [mm]	40	60	65	80	100
Non-cracked concrete						
Member thickness	$h \geq$ [mm]	140	230	270	340	410
Embedment depth	$h_{nom} \geq$ [mm]	80	120	150	200	220
Minimum spacing	s_{min} [mm]	40	50	60	80	100
Corresponding edge distance	$c \geq$ [mm]	40	70	80	100	130
Minimum edge distance	c_{min} [mm]	40	50	60	80	100
Corresponding spacing	$s \geq$ [mm]	40	145	160	160	235

Best case minimum member thickness and embedment depth with required minimum edge distance and spacing (borehole condition 1)

Anchor size		M8	M10	M12	M16	M20
Cracked concrete						
Member thickness	$h \geq$ [mm]	120	120	120	196	200
Embedment depth	$h_{nom} \geq$ [mm]	60	60	60	96	100
Minimum spacing	s_{min} [mm]	40	50	60	80	100
Corresponding edge distance	$c \geq$ [mm]	40	100	140	135	215
Minimum edge distance	$c_{min} =$ [mm]	40	60	90	80	125
Corresponding spacing	$s \geq$ [mm]	40	160	220	235	365
Non cracked concrete						
Member thickness	$h \geq$ [mm]	120	120	120	196	200
Embedment depth	$h_{nom} \geq$ [mm]	60	60	60	96	100
Minimum spacing	s_{min} [mm]	40	50	60	80	100
Corresponding edge distance	$c \geq$ [mm]	50	145	200	190	300
Minimum edge distance	c_{min} [mm]	40	80	115	110	165
Corresponding spacing	$s \geq$ [mm]	65	240	330	310	495

Minimum edge distance and spacing – Explanation

Minimum edge and spacing geometrical requirements are determined by testing the installation conditions in which two anchors with a given spacing can be set close to an edge without forming a crack in the concrete due to tightening torque.

The HIT-Z boundary conditions for edge and spacing geometry can be found in the tables to the left. If the embedment depth and slab thickness are equal to or greater than the values in the table, then the edge and spacing values may be utilized.

PROFIS Anchor software is programmed to calculate the referenced equations in order to determine the optimized related minimum edge and spacing based on the following variables:

Cracked or non-cracked concrete	For cracked concrete it is assumed that a reinforcement is present which limits the crack width to 0,3 mm, allowing smaller values for minimum edge distance and minimum spacing
Anchor diameter	For smaller anchor diameter a smaller installation torque is required, allowing smaller values for minimum edge distance and minimum spacing
Slab thickness and embedment depth	Increasing these values allows smaller values for minimum edge distance and minimum spacing

Installation equipment

Anchor size		M8	M10	M12	M16	M20	M24	M27	M30
Rotary hammer	HIT-V	TE 2 – TE 16				TE 40 - TE 80			
	HIT-Z	TE 2 – TE 40			TE 40 – TE 80		-		
	HIS-N	TE (-A) – TE 16(-A)		TE 40 – TE 80			-		
Other tools	compressed air gun and blow out pump, set of cleaning brushes, dispenser Hollow Drill Bit								

Cleaning, drilling and installation parameters

HIT-V	HIT-Z	HIS-N	Drill bit diameters d ₀ [mm]		Cleaning and installation	
			Hammer drill (HD)	Hollow Drill Bit (HDB)	Brush HIT-RB	Piston plug HIT-SZ
M8	M8	-	10	-	10	-
M10	M10	-	12	12	12	12
M12	M12	M8	14	14	14	14
M16	M16	M10	18	18	18	18
M20	M20	M12	22	22	22	22
M24	-	M16	28	28	28	28
M27	-	-	30	-	30	30
-	-	M20	32	32	32	32
M30	-	-	35	35	35	35



Setting instructions for HIT-V rods and HIS-N internally threaded sleeves

*For detailed information on installation see instruction for use given with the package of the product



Safety regulations.

Review the Material Safety Data Sheet (MSDS) before use for proper and safe handling! Wear well-fitting protective goggles and protective gloves when working with Hilti HIT-HY 200 A (R).

Drilling

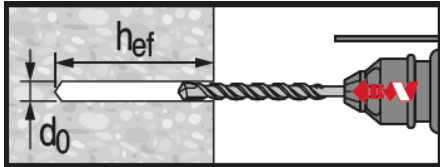

Hammer drilled hole (HD)

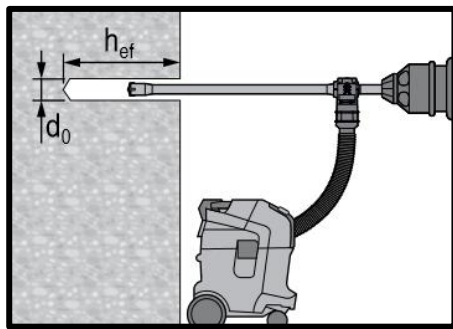

Hammer drilled hole with Hollow Drilled Bit (HDB)

No cleaning required

Cleaning

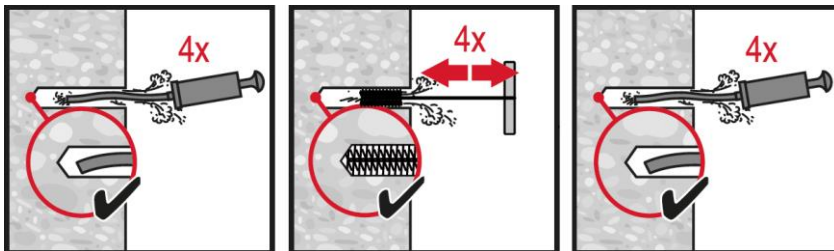

Manual cleaning (MC)

for drill diameters $d_0 \leq 20$ mm and drill hole depth $h_0 \leq 10 \cdot d$.

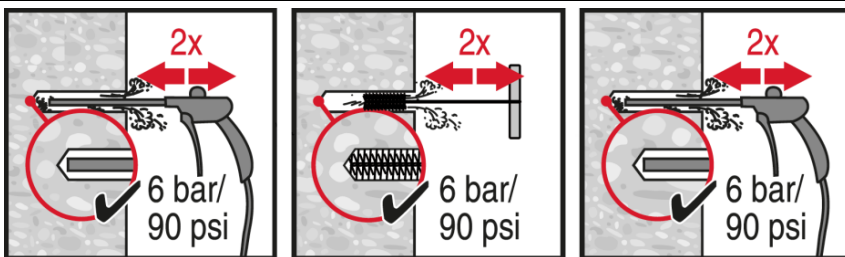

Compressed air cleaning (CAC)

for all drill hole diameters d_0 and drill hole depths $h_0 \leq 20 \cdot d$.

Injection

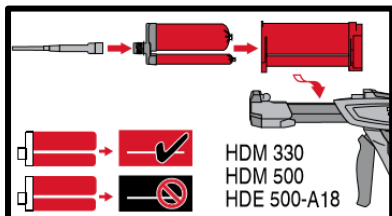

HDM 330
HDM 500
HDE 500-A18

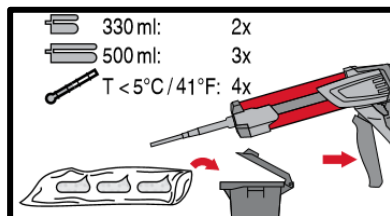

330 ml: 2x
500 ml: 3x
T < 5°C / 41°F: 4x

Injection system preparation.

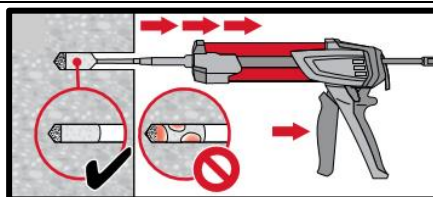
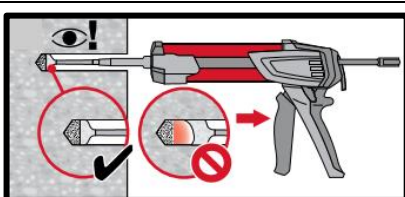

Injection method for drill hole depth $h_{ef} \leq 250$ mm.

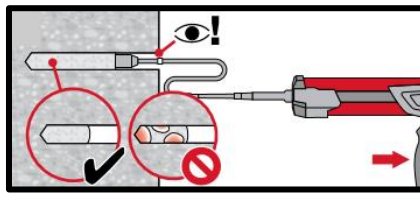
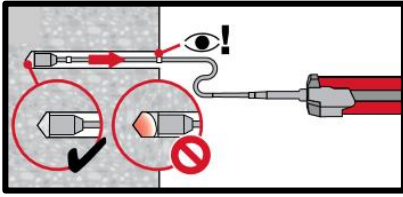

Injection method for drill hole depth $h_{ef} > 250\text{mm}$.

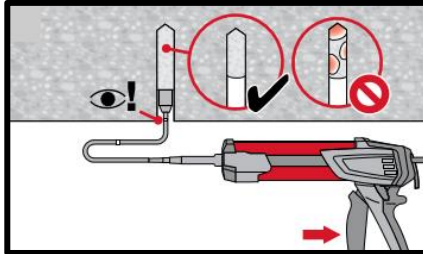
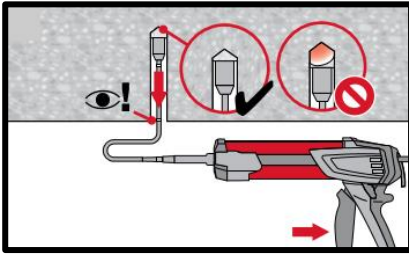

Injection method for overhead application and/or installation with embedment depth $> 250\text{ mm}$.

Setting the element

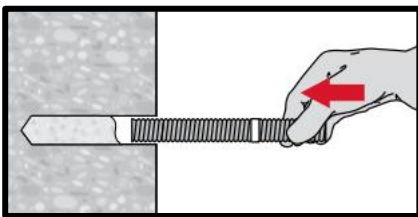

Setting element, observe working time " t_{work} ".

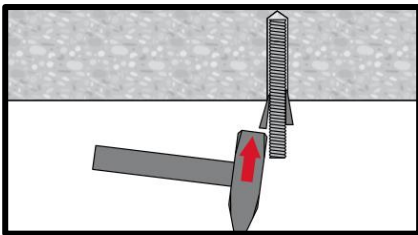

Setting element for overhead applications, observe working time " t_{work} ".

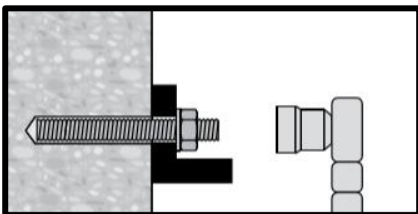

Loading the anchor after required curing time t_{cure}



Setting instructions for HIT-Z rods

*For detailed information on installation see instruction for use given with the package of the product.



Safety regulations.

Review the Material Safety Data Sheet (MSDS) before use for proper and safe handling! Wear well-fitting protective goggles and protective gloves when working with Hilti HIT-HY 200 A (R)

Drilling

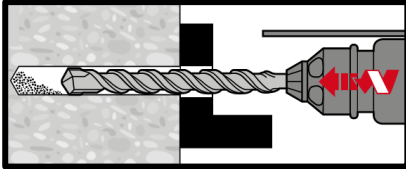

Hammer drilling: Through-setting

No cleaning required

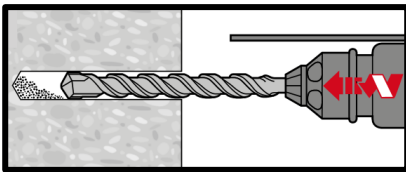

Hammer drilling: Pre-setting

No cleaning required

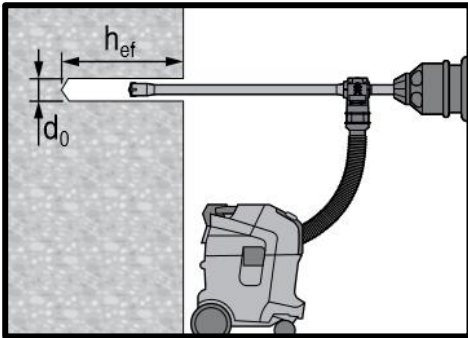

Hammer drilling with hollow drill bit: Through / pre-setting

No cleaning required

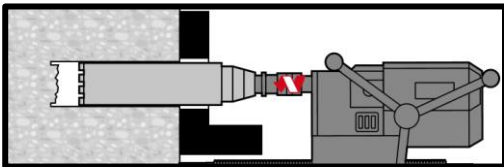

Diamond coring: Through-setting

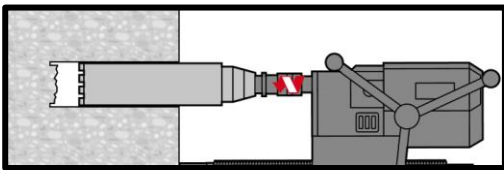

Diamond coring: Pre-setting

Cleaning

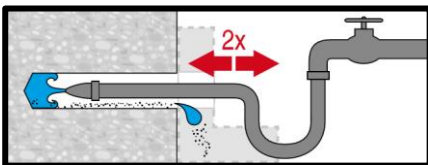

Hole flushing required for wet-drilled diamond cored holes.

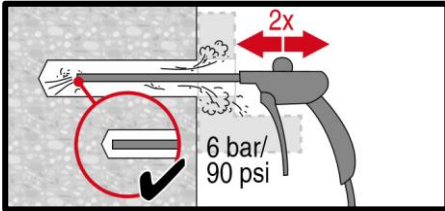

Evacuation required for wet-drilled diamond cored holes.

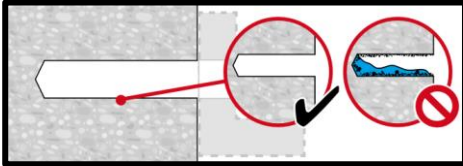

Injection

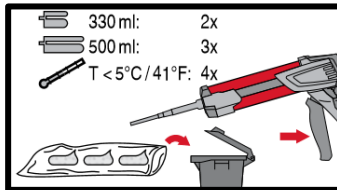
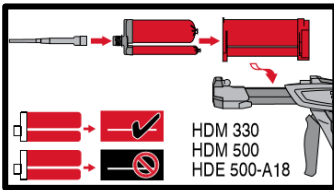

Injection system preparation.

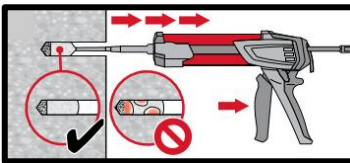
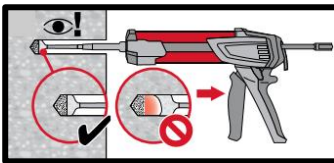

Injection of adhesive from the back of the drill hole without forming air voids.

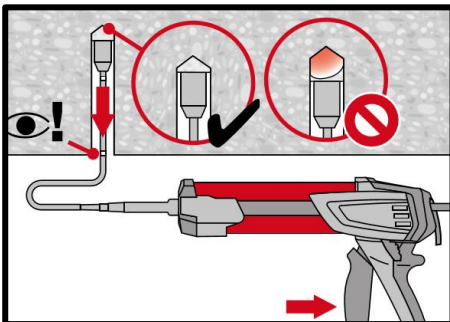

Overhead installation only with the aid of extensions and piston plugs.

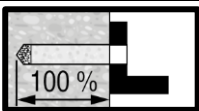

Through-setting:

Fill 100% of the drill hole.



Pre-setting:

Fill approx. 2/3 of the drill hole.

Setting the element

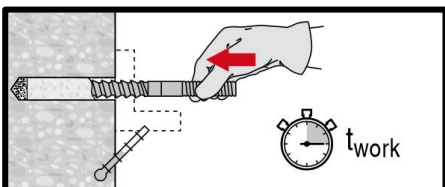

Setting element to the required embedment depth before working time "t_{work}" has elapsed.

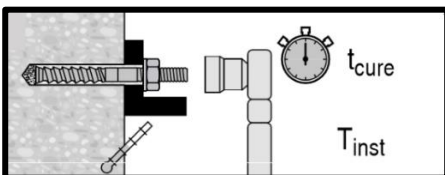

Loading the anchor: After required curing time t_{cure}.



Concrete

Chemical anchors

Mechanical anchors

Plastic / Light duty metal anchors

HIT-HY 200 injection mortar

Anchor design (ETAG 001) / Rebar elements / Concrete

Concrete

Chemical anchors

Mechanical anchors

Plastic / Light duty metal anchors

Injection mortar system

Benefits



Hilti HIT - HY 200-A

330 ml foil pack (also available as 500 ml foil pack)



Hilti HIT - HY 200-R

330 ml foil pack (also available as 500 ml foil pack)



Rebar B500 B
($\phi 8 - \phi 32$)

- **SafeSet** technology: drilling and borehole cleaning in one step with Hilti hollow drill bit
- ETA seismic approval C1
- Suitable for cracked and non-cracked concrete C 12/15 to C 50/60
- Suitable for dry and water saturated concrete
- High loading capacity, excellent handling
- Small edge distance and anchor spacing possible
- In service temperature range up to 120°C short term / 72°C long term
- Large diameter applications
- Two mortar versions: HY 200-A for slow cure applications and HY 200-R for fast cure applications

Base material

Load conditions



Concrete (non-cracked)



Concrete (cracked)



Dry concrete



Wet concrete



Static/quasi-static



Seismic, ETA-C1



Fire resistance

Installation conditions

Other informations

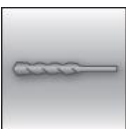

Hammer drilling

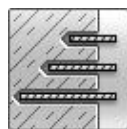

Variable embedment depth

SAFESET

Hilti **SafeSet** technology

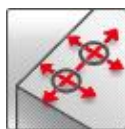

Small edge distance and spacing



European Technical Assessment



CE conformity



PROFIS Rebar design Software

Approvals / certificates

Description	Authority / Laboratory	No. / date of issue
European technical assessment ^{a)}	DIBt, Berlin	ETA-11/0493 / 2017-07-28
European technical assessment ^{a)}	DIBT, Berlin	ETA-12/0084 / 2017-02-03

^{a)} All data given in this section according to ETA-11/0493 issue 2017-07-28 and to ETA-12/0084 issue 2017-03-12.



Static and quasi-static loading (for a single anchor)

All data in this section applies to

- Correct setting (See setting instruction)
- No edge distance and spacing influence
- Steel failure
- Base material thickness, as specified in the table
- One typical embedment depth, as specified in the table
- One anchor material, as specified in the tables
- Concrete C 20/25, $f_{ck,cube} = 25 \text{ N/mm}^2$
- Temperate range I
(min. base material temperature -40°C , max. long term/short term base material temperature: $+24^\circ\text{C}/40^\circ\text{C}$)

Embedment depth and base material thickness for static and quasi-static loading data

Anchor- size	$\phi 8$	$\phi 10$	$\phi 12$	$\phi 14$	$\phi 16$	$\phi 20$	$\phi 25$	$\phi 26$	$\phi 28$	$\phi 30$	$\phi 32$
Typical embedment depth [mm]	80	90	110	125	145	170	210	230	270	285	300
Base material thickness [mm]	110	120	145	165	185	220	275	295	340	360	380

Mean ultimate resistance

Anchor- size	$\phi 8$	$\phi 10$	$\phi 12$	$\phi 14$	$\phi 16$	$\phi 20$	$\phi 25$	$\phi 26$	$\phi 28$	$\phi 30$	$\phi 32$
Non-cracked concrete											
Tensile $N_{Ru,m}$	29,4	45,0	65,1	87,6	93,7	148,6	204,0	233,9	297,4	297,4	348,4
Shear $V_{Ru,m}$	14,7	23,1	32,6	44,1	57,8	90,3	141,8	177,5	203,7	203,7	232,1
Cracked concrete											
Tensile $N_{Ru,m}$	-	18,8	38,5	51,1	58,4	99,3	145,4	212,0	212,0	212,0	248,3
Shear $V_{Ru,m}$	-	23,1	32,6	44,1	57,8	90,3	141,8	177,5	203,7	203,7	232,1

Characteristic resistance

Anchor- size	$\phi 8$	$\phi 10$	$\phi 12$	$\phi 14$	$\phi 16$	$\phi 20$	$\phi 25$	$\phi 26$	$\phi 28$	$\phi 30$	$\phi 32$
Non-cracked concrete											
Tensile N_{Rk}	24,1	33,9	49,8	66,0	87,5	111,9	153,7	176,2	224,1	243,0	262,4
Shear V_{Rk}	14,0	22,0	31,0	42,0	55,0	86,0	135,0	146,0	169,0	194,0	221,0
Cracked concrete											
Tensile N_{Rk}	-	14,1	29,0	38,5	51,0	74,8	109,6	125,6	159,7	173,2	187,1
Shear V_{Rk}	-	22,0	31,0	42,0	55,0	86,0	135,0	146,0	169,0	194,0	221,0

Design resistance

Anchor- size	$\phi 8$	$\phi 10$	$\phi 12$	$\phi 14$	$\phi 16$	$\phi 20$	$\phi 25$	$\phi 26$	$\phi 28$	$\phi 30$	$\phi 32$
Non-cracked concrete											
Tensile N_{Rd}	16,1	22,6	33,2	44,0	58,3	74,6	102,5	117,4	149,4	162,0	174,9
Shear V_{Rd}	9,3	14,7	20,7	28,0	36,7	57,3	90,0	97,3	112,7	129,3	147,3
Cracked concrete											
Tensile N_{Rd}	-	9,4	19,4	25,7	34,0	49,8	73,0	83,7	106,5	115,5	124,7
Shear V_{Rd}	-	14,7	20,7	28,0	36,7	57,3	90,0	97,3	112,7	129,3	147,3

Recommended loads

Anchor- size	φ8	φ10	φ12	φ14	φ16	φ20	φ25	φ26	φ28	φ30	φ32
Non-cracked concrete											
Tensile N_{Rec} [kN]	§	16,2	23,7	31,4	33,6	53,3	73,2	106,7	106,7	125,0	11,5
Shear V_{Rec} [kN]	6,7	10,5	14,8	20,0	26,2	41,0	64,3	80,5	92,4	105,2	6,7
Cracked concrete											
Tensile N_{Rec} [kN]	-	6,7	13,8	18,3	20,9	35,6	52,2	76,1	76,1	89,1	6,7
Shear V_{Rec} [kN]	-	10,5	14,8	20,0	26,2	41,0	64,3	80,5	92,4	105,2	10,5

With overall partial safety factor for action $\gamma=1,4$. The partial safety factors for action depend on the type of loading and shall be taken from national regulations.

Seismic loading (for a single anchor)

All data in this section applies to:

- Correct setting (See setting)
- No edge distance and spacing influence
- Steel failure
- Minimum base material thickness
- Concrete C 20/25, $f_{ck,cube} = 25 \text{ N/mm}^2$
- Temperature range I
(min, base material temperature -40°C , max, long term/short term base material temperature: $+24^\circ\text{C}/40^\circ\text{C}$)
- $\alpha_{gap} = 1,0$

Embedment depth and base material thickness in case of seismic performance category C1

Anchor- size	φ8	φ10	φ12	φ14	φ16	φ20	φ25	φ26	φ28	φ30	φ32
Typical embedment depth [mm]	-	90	110	125	145	170	210	230	270	285	300
Base material thickness [mm]	-	120	145	165	185	220	275	295	340	360	380

Characteristic resistance in case of seismic performance category C1

Anchor- size	φ8	φ10	φ12	φ14	φ16	φ20	φ25	φ26	φ28	φ30	φ32
Tensile $N_{Rk, se}$ [kN]	-	12,4	25,3	33,5	38,3	65,2	93,1	135,8	135,8	159,0	12,4
Shear $V_{Rk, se}$ [kN]	-	15,0	22,0	29,0	39,0	60,0	95,0	102,0	112,0	135,0	165,0

Design resistance in case of seismic performance category C1

Anchor- size	φ8	φ10	φ12	φ14	φ16	φ20	φ25	φ26	φ28	φ30	φ32
Tensile $N_{Rd, se}$ [kN]	-	8,3	16,9	22,4	25,6	43,4	62,1	90,5	90,5	106,0	8,3
Shear $V_{Rd, se}$ [kN]	-	10,0	14,7	19,3	26,0	40,0	63,3	68,0	74,7	90,0	110,0

Materials

Mechanical properties

Anchor size	φ8	φ10	φ12	φ14	φ16	φ20	φ25	φ26	φ28	φ30	φ32
Nominal tensile strength f_{uk} [N/mm ²]	550	550	550	550	550	550	550	550	550	550	550
Yield strength f_{yk} [N/mm ²]	500	500	500	500	500	500	500	550	500	550	500
Stressed cross-section A_s [mm ²]	50,3	78,5	113,1	153,9	201,1	314,2	490,9	530,9	615,8	706,9	804,2
Moment of resistance W [mm ³]	50,3	98,2	169,6	269,4	402,1	785,4	1534	1726	2155	2651	3217



Material quality

Part	Material
Rebar EN 1992-1-1:2004 and AC:2010	Bars and de-coiled rods class B or C according to NDP or NCL of EN 1992-1-1/NA:2013

Setting information

Installation temperature range

- 10°C to + 40°C

Service temperature range

Hilti HIT-HY 200 injection mortar may be applied in the temperature ranges given below, An elevated base material temperature may lead to a reduction of the design bond resistance,

Temperature range	Base material temperature	Max, long term base material temperature	Max, short term base material temperature
Temperature range I	-40 °C to + 40 °C	+ 24 °C	+ 40 °C
Temperature range II	-40 °C to + 80 °C	+ 50 °C	+ 80 °C
Temperature range III	-40 °C to + 120 °C	+ 72 °C	+ 120 °C

Max, short term base material temperature

Short term elevated base material temperatures are those that occur over brief intervals, e.g, as a result of diurnal cycling,

Max, long term base material temperature

Long term elevated base material temperatures are roughly constant over significant periods of time,

Curing and working time

Temperature of the base material	HIT-HY 200-A		HIT-HY 200-R	
	Maximum working time t_{work}	Minimum curing time t_{cure}	Maximum working time t_{work}	minimum curing time t_{cure}
- 10°C < T_{BM} ≤ - 5°C	1,5 h	7 h	3 h	20 h
- 5°C < T_{BM} ≤ 0°C	50 min	4 h	2 h	8 h
0°C < T_{BM} ≤ 5°C	25 min	2 hour	1 h	4 h
5°C < T_{BM} ≤ 10°C	15 min	75 min	40 min	2,5 h
10°C < T_{BM} ≤ 20°C	7 min	45 min	15 min	1,5 h
20°C < T_{BM} ≤ 30°C	4 min	30 min	9 min	1 h
30°C < T_{BM} ≤ 40°C	3 min	30 min	6 min	1 h

The curing time data are valid for dry base material only, In wet base material the curing times must be doubled,

Installation equipment

Anchor size	φ8	φ10	φ12	φ14	φ16	φ20	φ25	φ26	φ28	φ30	φ32
Rotary hammer	TE 2 (-A) – TE 16 (-A)					TE 40 – TE 80					
Other tools	Compressed air gun, blow out pump Set of cleaning brushes, dispenser										

Setting details

Anchor size		Ø8	Ø10	Ø12	Ø14	Ø16	Ø20	Ø25	Ø26	Ø28	Ø30	Ø32
Nominal diameter of drill bit	d_0 [mm]	10 / 12 ^{a)}	12 / 14 ^{a)}	14 / 16 ^{a)}	18	20	25	32	32	35	37	40
Effective anchorage and drill hole depth range ^{b)}	$h_{ef,min}$ [mm]	60	60	70	75	80	90	100	104	112	120	128
	$h_{ef,max}$ [mm]	160	200	240	280	320	400	500	520	560	600	640
Minimum base material thickness	h_{min} [mm]	$h_{ef} + 30 \text{ mm} \geq 100 \text{ mm}$			$h_{ef} + 2 d_0$							
Minimum spacing	s_{min} [mm]	40	50	60	70	80	100	125	130	140	150	160
Minimum edge distance	c_{min} [mm]	40	45	45	50	50	65	70	75	75	80	80
Critical spacing for splitting failure	$s_{cr,sp}$ [mm]	$2 c_{cr,sp}$										
Critical edge distance for splitting failure ^{c)}	$c_{cr,sp}$ [mm]	$1,0 \cdot h_{ef}$		for $h / h_{ef} \geq 2,0$								
		$4,6 h_{ef} - 1,8 h$		for $2,0 > h / h_{ef} > 1,3$								
		$2,26 h_{ef}$		for $h / h_{ef} \leq 1,3$								
Critical spacing for concrete cone failure	$s_{cr,N}$ [mm]	$2 c_{cr,N}$										
Critical edge distance for concrete cone failure ^{d)}	$c_{cr,N}$ [mm]	$1,5 h_{ef}$										

For spacing (edge distance) smaller than critical spacing (critical edge distance) the design loads have to be reduced.

- a) Both given values for drill bit diameter can be used
- b) $h_{ef,min} \leq h_{ef} \leq h_{ef,max}$ (h_{ef} : embedment depth)
- c) h : base material thickness ($h \geq h_{min}$)
- d) The critical edge distance for concrete cone failure depends on the embedment depth h_{ef} and the design bond resistance. The simplified formula given in this table is on the safe side.

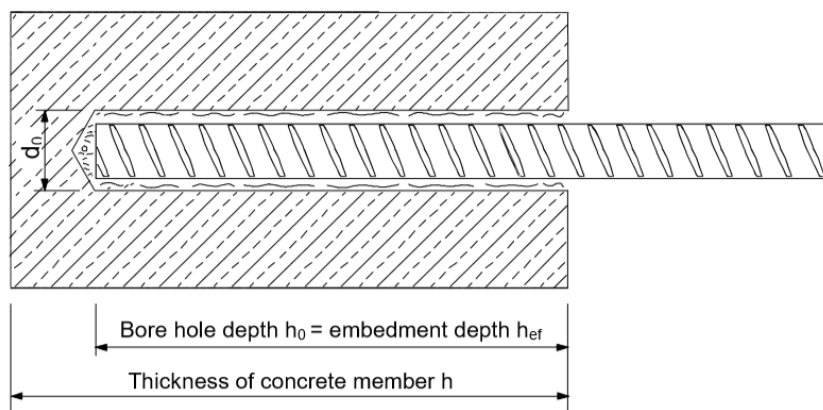
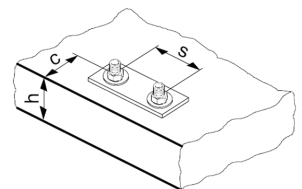



Rebar	Hammer drill (HD)	Hollow Drill Bit (HDB)	Brush HIT-RB
	d_0 [mm]		size [mm]
$\phi 8$	12 / 10 ^{a)}	12	12 / 10 ^{a)}
$\phi 10$	14 / 12 ^{a)}	14 / 12 ^{a)}	14 / 12 ^{a)}
$\phi 12$	16 / 14 ^{a)}	16 / 14 ^{a)}	16 / 14 ^{a)}
$\phi 14$	18	18	18
$\phi 16$	20	20	20
$\phi 20$	25	25	25
$\phi 25$	32	32	32
$\phi 26$	32	32	32
$\phi 28$	35	35	35
$\phi 30$	37	-	37
$\phi 32$	40	-	40

a) Both given values can be used

Setting instructions

*For detailed information on installation see instruction for use given with the package of the product,



Safety regulations.

Review the Material Safety Data Sheet (MSDS) before use for proper and safe handling! Wear well-fitting protective goggles and protective gloves when working with Hilti HIT-HY 200.

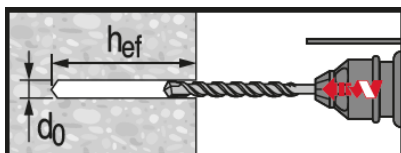

Hammer drilled hole (HD)

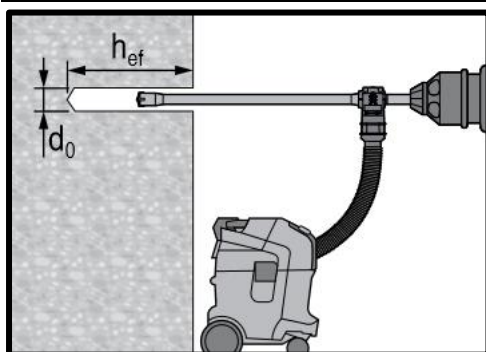

Hammer drilled hole with Hollow Drilled Bit (HDB)

No cleaning required

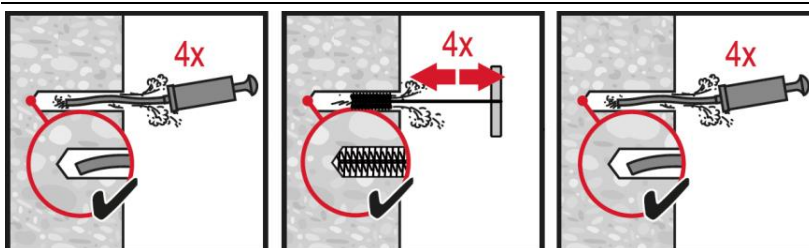

Manual cleaning (MC)

for drill diameters $d_0 \leq 20$ mm and drill hole depth $h_0 \leq 10 \cdot d_0$.